

Schottky Barrier Diodes

40V

V _{RM} (V)	Package	Part Number	I _F (AV) (A)	I _{FSM} (A)	T _J (°C)	T _{stg} (°C)	V _F (V) max	I _F (A)	I _R (mA)	I _R (H) (mA)	Ta (°C)	R _{th} (j-ℓ) R _{th} (j-c) (°C/W)	Mass (g)	Fig. No.	Page where characteristic curve is shown
				50Hz Half-cycle Sinewave Single Shot					V _R =V _{RM} max	V _R =V _{RM} max					
40	Surface Mount	SFPB-54	1.0	30	-40 to +150	0.55	1.0	1	50	100	20	0.072	1	82	
		SFPB-64	1.5	60	-40 to +150	0.55	2.0	5	50	100	20	0.072		83	
		SFPB-74	2.0	60	-40 to +150	0.5	2.0	5	50	100	20	0.072		—	
		SPB-G34S	3.0	50	-40 to +150	0.55	3.0	3.5	50	100	5	0.29	2	84	
		SPB-G54S	5.0	60	-40 to +150	0.55	5.0	5	50	100	5	0.29			
		Surface Mount Center-tap	SPB-64S	6.0	50	-40 to +150	0.55	3.0	3.5	50	100	5	0.29		
	Axial	AK 04	1.0	25	-40 to +150	0.55	1.0	1	50	100 (Tj)	22	0.13	3	85	
		AW 04	1.0	25	-40 to +150	0.58	1.0	5	35	150	22	0.13		—	
		AE 04	1.0	25	-40 to +150	0.6	1.0	0.1	10	150 (Tj)	22	0.13		—	
		EK 04	1.0	40	-40 to +150	0.55	1.0	5	50	100	20	0.3	4	86	
		EE 04 *	2.0	40	-40 to +150	0.6	2.0	0.2	20	150 (Tj)	20	0.3		—	
		EK 14	1.5	40	-40 to +150	0.55	2.0	5	50	100	17	0.3	5	86	
		RK 14	1.7	60	-40 to +150	0.55	2.0	5	50	100	15	0.45		6	87
		RK 34	2.5	50	-40 to +150	0.55	2.5	5	50	100	12	0.6	7		
	RK 44	3.0	80	-40 to +150	0.55	3.0	5	50	100	8	1.2	8		88	
	Frame-2Pin	FMB-G14	3.0	60	-40 to +150	0.55	3.0	5	100	100	4		2.1		9
		FMB-G14L	5.0	60	-40 to +150	0.55	5.0	5	100	100	4	2.1			
		FMB-G24H	10.0	150	-40 to +150	0.55	10.0	10	65	100	4	2.1			
	Center-tap	MPE-24H	15	100	-40 to +150	0.6	7.5	0.75	50	150 (Tj)	2.5	1.04	10/10	85	
		FMB-24	4.0	50	-40 to +150	0.55	2.0	5	35	100	4	2.1	11	90	
		FMB-24M	6.0	60	-40 to +150	0.55	3.0	5	35	100	4	2.1		91	
		FMW-24L	10.0	100	-40 to +150	0.55	5.0	5	175	150	4	2.1		90	
		FMB-24L	10	60	-40 to +150	0.55	5.0	5	35	100	4	2.1	12	94	
		FME-2104	10	80	-40 to +150	0.6	5.0	0.5	30	100	4	2.1			
		FMB-34S	12	75	-40 to +150	0.58	6	5	35	100	2	5.5	11	90	
		FMW-24H	15	120	-40 to +150	0.55	7.5	7.5	250	150	4	2.1			
		FME-24H	15	100	-40 to +150	0.6	7.5	0.75	50	100	4	2.1	12	92	
		FMB-24H	15	100	-40 to +150	0.55	7.5	7.5	50	100	4	2.1			
FMB-34		15	150	-40 to +150	0.55	7.5	10	65	100	2	5.5	11	93		
FMB-2204		20	150	-40 to +150	0.55	10	10	350	150	4	2.1			—	
FMW-2204		20	120	-40 to +150	0.55	10	10	350	150 (Tj)	4	2.1	12	81		
FMB-2304		30	150	-40 to +150	0.55	15	15	500	150	4	2.1		91		
FMB-34M	30	300	-40 to +150	0.55	15.0	20	100	100	2	5.5	12	93			

* : Under development

Schottky Barrier Diodes 40V

External Dimensions Flammability: UL94V-0 or Equivalent (Unit: mm)

1

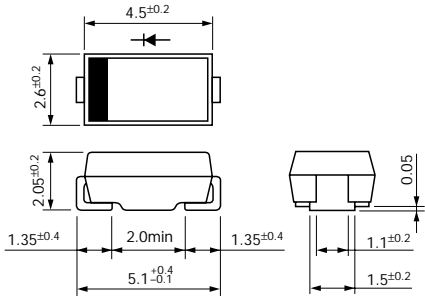

2

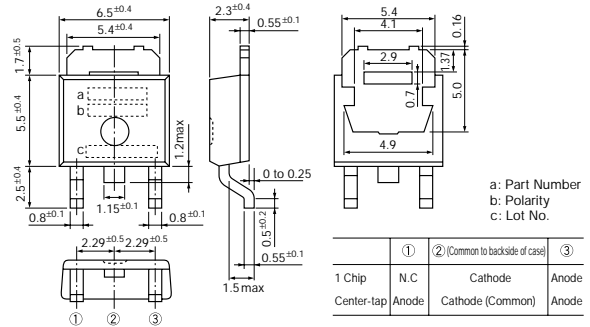

3

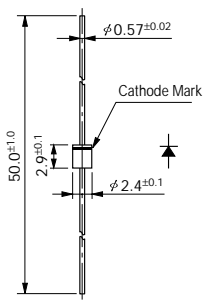

4

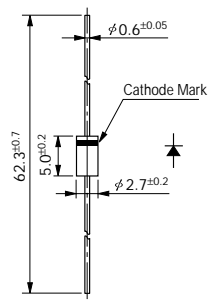

5

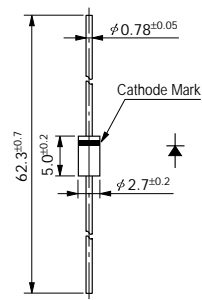

6

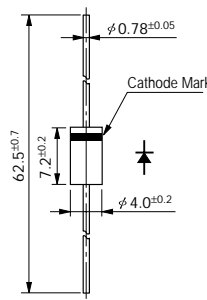

7

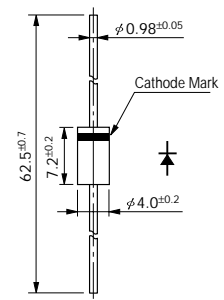

8

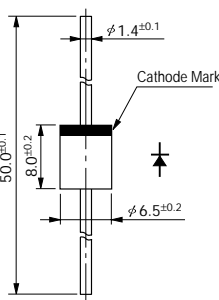

9

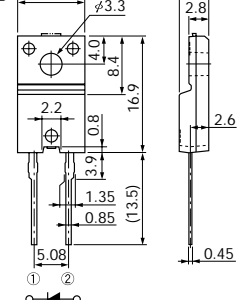

10

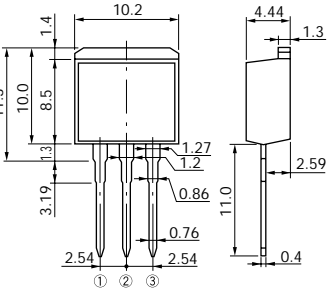

10

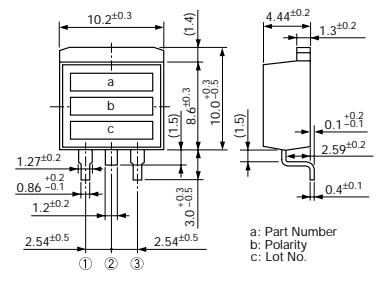

11

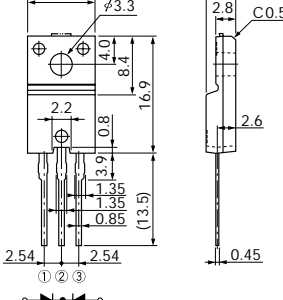

12

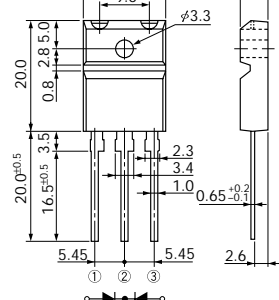

Characteristic Curves Schottky Barrier Diodes

FMB-24

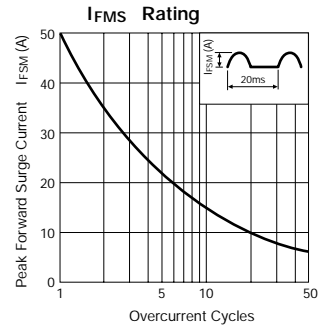
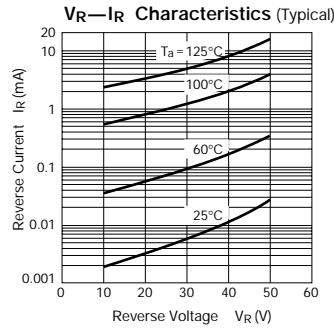
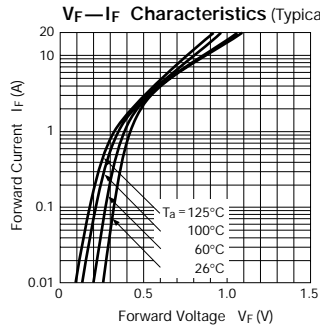
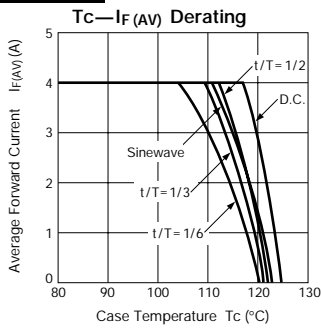

FMB-24H

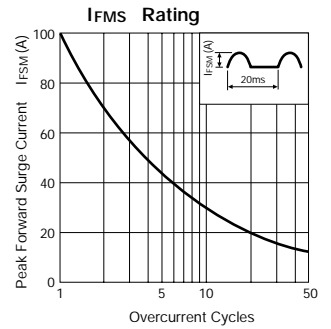
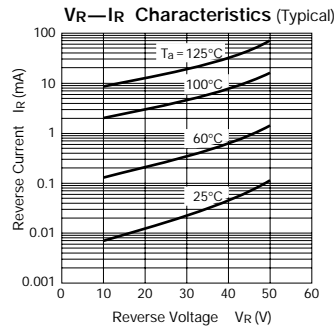
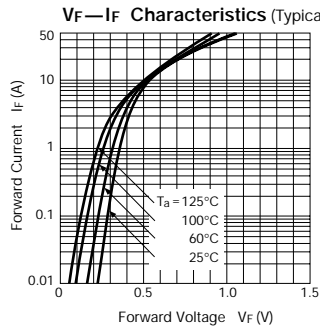
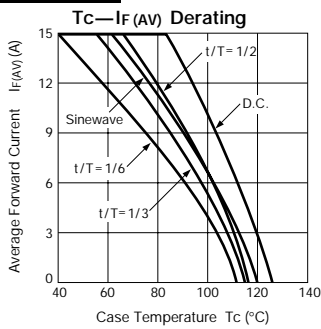

FMW-24H

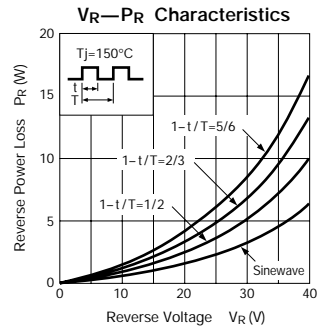
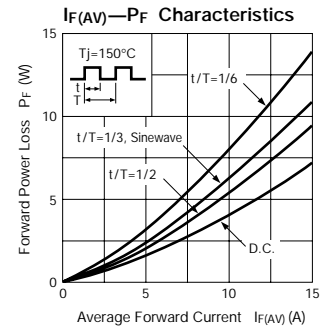
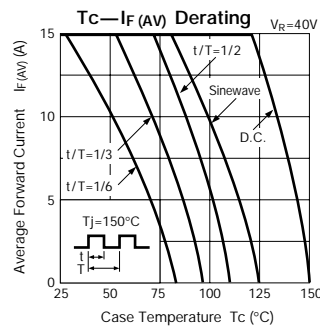
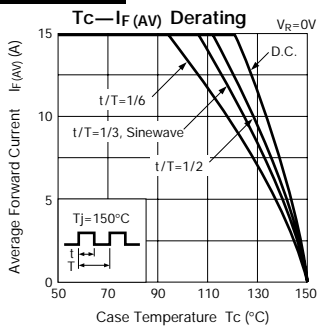

FMB-24L

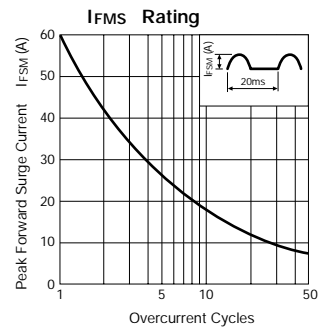
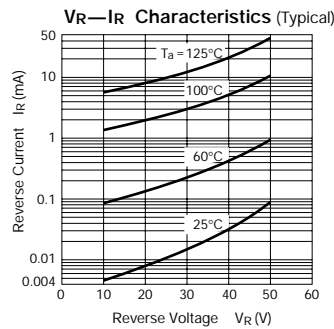
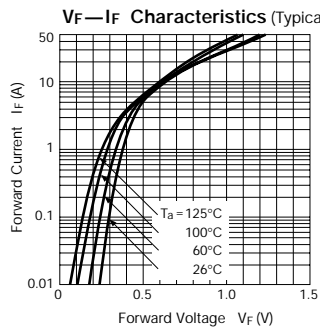
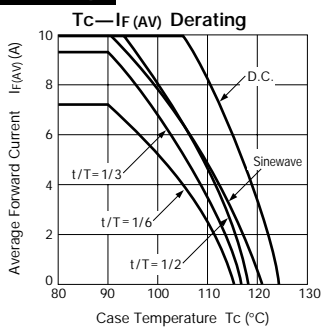

FMW-24L

